

GD-52100
GD-52101

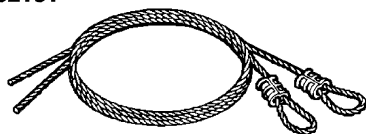

GD-52100 (1/8" cable)
GD-52101 (3/32" cable)

Extension Cables

Contents: 2 - 12' cables with loop ends.

Description: Galvanized carbon steel aircraft cables used on extension spring doors. 1/8" replaces most wood doors, 3/32" replaces most fiberglass and aluminum doors.

GD-52161



GD-52161

Extension Cables (Heavy duty)

Contents: 2 - 14' cables with loop ends.

Description: 5/32" galvanized carbon steel aircraft cables used on extension spring garage doors; replaces heavy duty wood, fiberglass and aluminum door applications.

You may also wish to stock these related parts: **GD-52100**, **GD-52101**.

GD-52102
GD-52240

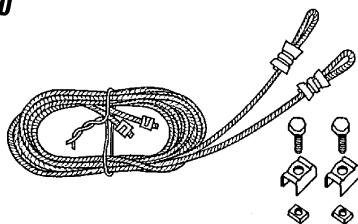

GD-52102 (2 pack)
GD-52240 (4 pack)

Safety Cables

Contents: 8' 6" cables with cable clamp set.

Description: 1/8" galvanized carbon steel aircraft cables; installs through extension springs to prevent injury in case of breakage. Required on California installations. 4 cable set used on dual spring doors.

GD-52183

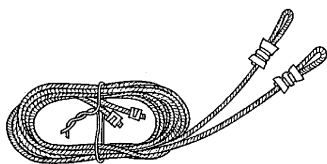

GD-52183

Torsion Spring Cables

Contents: 2 - 8' 8" cables with loop ends and stops.

Description: 1/8" galvanized carbon steel aircraft cable; for use on torsion spring doors, 7 feet high.

You may also wish to stock these related parts: **GD-52115**, **GD-52116**.

GD-52262

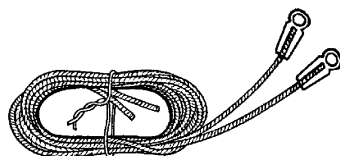

GD-52262

Extension Spring Cables

Contents: 2 - 13' 6" cables.

Description: 1/8" galvanized carbon steel aircraft cable. Special end clip designed for *Phoenix* doors.

Garage Door

GD-52263

Torsion Spring Cables

Contents: 2 - 8' 8" cables.

Description: 3/32" galvanized carbon steel aircraft cables; used on both single and double garages, fits glass doors.

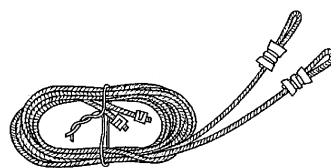

GD-52263

GD-12149 (1/16")

GD-12150 (3/32")

GD-12151 (1/8")

GD-12152 (5/32")

GD-12153 (3/16")

GD-12154 (1/4")

GD-12256 (5/16")

GD-12257 (3/8")

Cable Ferrules and Stops

Contents: 2 ferrules; 2 stops.

Description: Extruded aluminum ferrules are used to clamp cable loops into fixed position; stops finish off end of cable or as a stopping point at any location on cable. Select from eight stock cable sizes.

You may wish to stock these related parts: **GD-52100**, **GD-52101**, **GD-52161**.

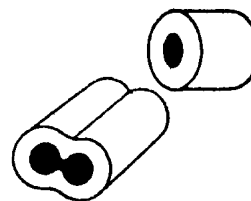

Ferrules and Stops

GD-12170 (1/16")

GD-12172 (3/32")

GD-12174 (1/8")

GD-12176 (5/32")

GD-12178 (3/16")

GD-12180 (1/4")

GD-12258 (5/16")

GD-12259 (3/8")

Cable Ferrules (Bulk)

Contents: 100 bulk: GD-12170, GD-12172 and GD-12174
50 bulk: GD-12176
30 bulk: GD-12178
20 bulk: GD-12180
20 bulk: GD-12258
20 bulk: GD-12259

Description: Extruded aluminum ferrules are used to clamp cable loops into fixed position; select from eight stock cable sizes.

You may wish to stock these related parts: **GD-52100**, **GD-52101**, **GD-52161**.



Ferrules Only

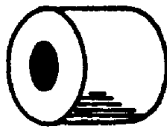

Stops Only

- GD-12171** (1/16")
- GD-12173** (3/32")
- GD-12175** (1/8")
- GD-12177** (5/32")
- GD-12179** (3/16")
- GD-12181** (1/4")

Cable Stops (Bulk)

Contents: 100 bulk: GD-12171, GD-12173 and GD-12175
 50 bulk: GD-12177
 30 bulk: GD-12179
 20 bulk: GD-12181

Description: Extruded aluminum stops are used to finish off end of cable or as a stopping point at any location on cable. Select from six stock cable sizes.

You may wish to stock these related parts: **GD-52100**, **GD-52101**.

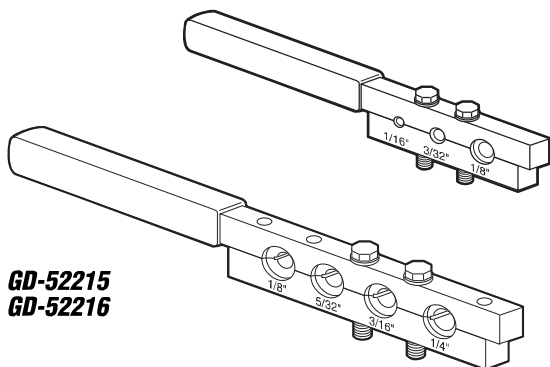

GD-52215
GD-52216

- GD-52215** (1/16" - 1/8")
- GD-52216** (1/8" - 1/4")

Swage-it Tool

Contents: 1 tool.

Description: Heavy duty 2 piece steel swage-it tool for crimping cable ferrules to cable; not designed for crimping stops.

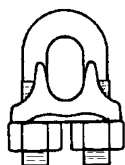

Cable Clamps

- GD-12251** (1/16")
- GD-12260** (3/32")
- GD-12155** (1/8")
- GD-12261** (5/32")
- GD-12156** (3/16")
- GD-12157** (1/4")
- GD-12252** (5/16")
- GD-12253** (3/8")
- GD-12254** (1/2")

Cable Clamps

Contents: 2 cable clamp assemblies.

Description: Steel bolts and nuts; cast aluminum base; used to clamp cable loops into fixed positions; normal loop assembly uses 3 clamps.

You may wish to stock these related parts: **GD-12149** thru **GD-12154**, **GD-12256**, **GD-12257**.

Garage Door

GD-12246 (1/16")
GD-12158 (1/8")
GD-12247 (5/32")
GD-12159 (3/16")
GD-12160 (1/4")
GD-12248 (5/16")
GD-12249 (3/8")

Cable Thimbles

Contents: 2 cable thimbles.

Description: Carbon steel, zinc plated thimble forms non-collapsible loop in cable; protects cable strands from wear damage.

You may wish to stock these related parts: **GD-12151**, **GD-12153**, **GD-12154**.

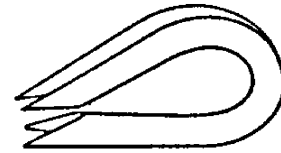

Cable Thimbles

GD-52108 (4" Diameter)
GD-52109 (3" Diameter)

Pulley With Strap and Axle Bolt

Contents: 1 pulley; 1 strap; 1 axle bolt with nut.

Description: Heavy duty galvanized steel pulley with galvanized steel strap; case hardened steel race with steel ball bearings; factory lubricated; can be used at stationary or spring pulley positions.

GD-52108
GD-52109

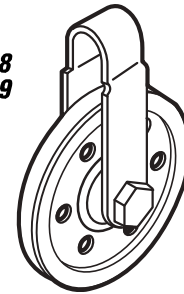

GD-52189 (2 pack)

Pulley With Strap and Axle Bolt (3" Diameter)

Contents: 2 pulleys; 2 straps; 2 axle bolts with nuts.

Description: Heavy duty galvanized steel pulley with galvanized steel strap; case hardened steel race with steel ball bearings; factory lubricated; can be used at stationary or spring pulley positions.

You may wish to stock this related part: **GD-52109**.

GD-52189

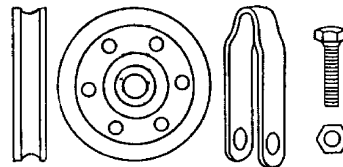

Rollers

Contents: See Chart Below.

Description: Steel ball bearing rollers with steel inner race; factory lubricated; a selection to replace most garage door rollers.

Part No.	Dim. A	Dim. B	Dim. C	Dim. D	Pkg. Qty.	Desc.
GD-52110	1-7/8"	4"	7/16"	2"	2	Standard
GD-52112	1-5/16"	2-7/8"	5/16"	1-3/8"	2	Frantz 1"
GD-52113	1-7/8"	4-1/4"	5/16"	2"	2	Frantz 1/4"
GD-52114	1-7/8"	4-1/2"	3/8"	2"	2	Frantz 3/8"
GD-52190	1-7/8"	4"	7/16"	2"	4	Standard

You may wish to stock these related parts: **GD-12140**, **GD-12203**.

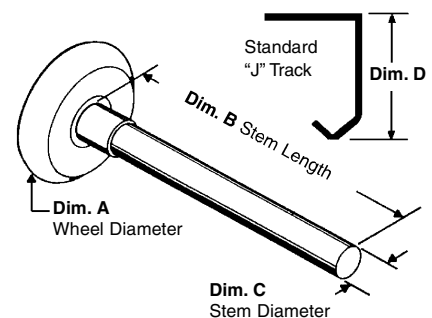

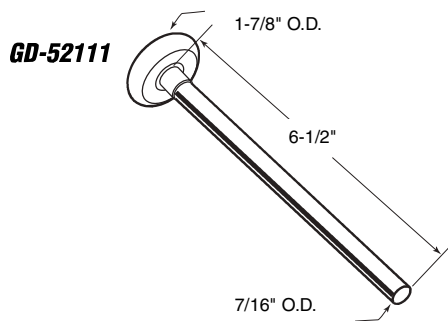

GD-52111

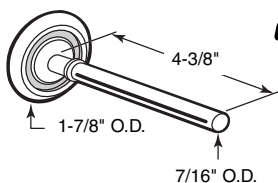

GD-52212

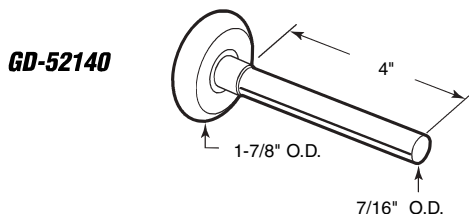

GD-52140

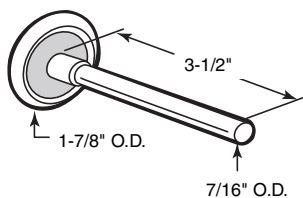

**GD-52203
GD-52239**

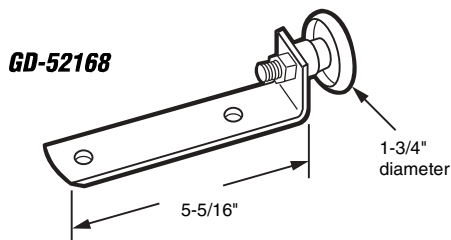

GD-52168

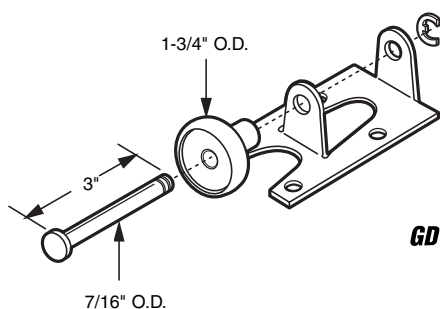

GD-52211

GD-52111 (Steel ball bearing)

Heavy Duty Roller (Long stem)

Contents: 1 roller assembly.

Description: Heavy duty **steel roller** with **steel inner race**; **10 ball bearings**; factory lubricated; used on side by side hinge placements for added strength.

You may wish to stock these related parts: **GD-52140**, **GD-52203**.

GD-52212 (Steel ball bearing)

Heavy Duty Roller (Short stem)

Contents: 2 roller assemblies.

Description: Heavy duty **steel roller** with **steel inner race**; **10 ball bearings**; same as **GD-52111** but, with shorter stem.

GD-52140 (Nylon ball bearing)

Standard Roller (For 2" track)

Contents: 2 roller assemblies.

Description: **Steel ball bearing** with **steel inner race** and **nylon tire** for smooth operation; **steel shaft**; factory lubricated; excellent performance in all weather conditions.

You may wish to stock these related parts: **GD-52140**, **GD-52203**.

GD-52203 (2 pack)

GD-52239 (4 pack)

Standard Roller (Plastic)

Contents: Roller assemblies.

Description: **High impact plastic rollers** have outstanding performance characteristics in all weather environments; quiet, trouble free operation.

You may wish to stock these related parts: **GD-52110**, **GD-52140**.

GD-52168

Roller and Bracket

Contents: 1 roller and bracket.

Description: **Plastic roller** and **steel bracket**; designed for **Taylor** one-piece garage doors; requires 4 rollers per door.

Call for
Availability

GD-52211

Roller and Bracket

Contents: 1 roller and bracket.

Description: **Plastic roller** and **steel bracket** designed for **Stanley** one-piece steel garage doors; use 4 rollers per door.

Garage Door

GD-52104 (# 1 position & center)

GD-52105 (# 2 position)

GD-52106 (# 3 position)

GD-52107 (# 4 position)

**14 gauge
1 per card**

Standard Hinge (3" overall width)

Contents: 1 hinge; 4 ea. 1/4"- 20 x 1-7/8" pancake head carriage bolts with nuts.

Description: Heavy duty 14 gauge galvanized steel hinge; roller tube accepts a standard 7/16" diameter stem roller; used by most garage door manufacturers.

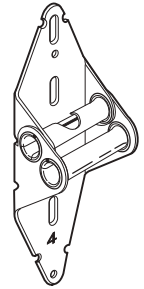

GD-52185 (# 1 position & center)

GD-52186 (# 2 position)

GD-52187 (# 3 position)

GD-52188 (# 4 position)

**14 gauge
2 per card**

Standard Hinge (3" overall width)

Contents: 2 hinges without fasteners.

Description: Heavy duty 14 gauge galvanized steel hinge; roller tube accepts a standard 7/16" diameter stem roller; used by most garage door manufacturers.

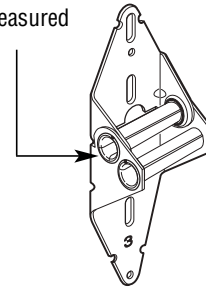

GD-52242 (# 1 position & center)

GD-52243 (# 2 position)

GD-52244 (# 3 position)

GD-52245 (# 4 position)

**18 gauge
1 per card**

Narrow Hinge (2-1/4" overall width)

Contents: 1 hinge; 4 each 1/4-20x1-7/8" pancake head carriage bolts.

Description: Medium duty 18 gauge galvanized steel hinge; used by many garage door manufacturers; roller tube accepts a standard 7/16" diameter stem roller.

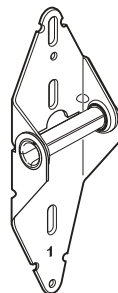

GD-52167

Quick Turn Fixture

Contents: 1 fixture.

Description: Heavy duty galvanized steel; for use on low headroom garage door conditions, where automatic openers are installed.

You may also wish to stock these related parts: **GD-52110**, **GD-52111**.

GD-52167

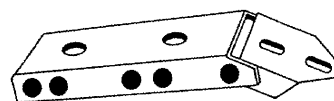

Call for
Availability

GD-52163

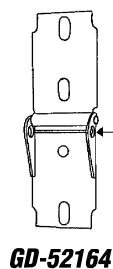
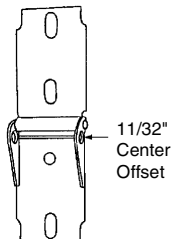

GD-52165

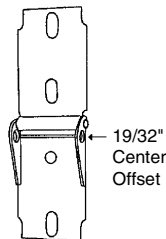

GD-52163 (#1 position)
GD-52164 (#2 position)
GD-52165 (#3 position)

Hinge (For fiberglass doors)

Contents: 2 hinges; 8 ea. 1/4"-20 x 3/4" installation bolts.

Description: Heavy duty **galvanized steel**; accepts a **5/16" diameter stem roller**; fits on *Frantz* on 1200 (wood), 2400 and 2600 series doors.

You may wish to stock these related parts: **GD-52112**, **GD-52113**, **GD-52162**, **GD-52164**, **GD-52165**.

GD-52162

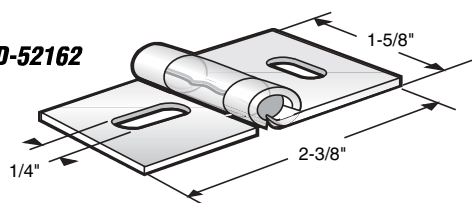

Call for
Availability

GD-52162

Center Hinge (For fiberglass doors)

Contents: 2 hinges; 4 ea. 1/4"-20 x 3/4" installation bolts.

Description: Heavy duty **galvanized steel**; old style application; fits on *Frantz* on 1200, 2400 and 2600 series doors.

You may wish to stock these related parts: **GD-52163**, **GD-52164**, **GD-52165**.

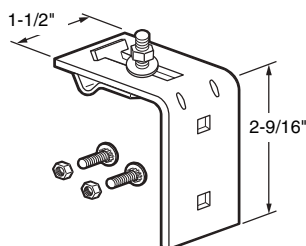

GD-52218

GD-52218

Top Fixture Bracket

Contents: 1 bracket; 2 ea. 1/4"-20 x 1/2" ribbed neck bolts and nuts.

Description: **Steel bracket**; adjustable; fits *Frantz* fiberglass doors.

GD-52117

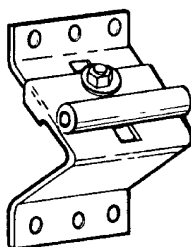

GD-52117

Top Roller Fixture

Contents: 1 fixture; 4 ea. 1/4" -20 x 1-7/8" pancake head carriage bolts with nuts.

Description: Heavy duty **galvanized steel** fixture with adjustable roller plate; accepts a standard **7/16" diameter stem roller**; used on most wood doors.

GD-52196

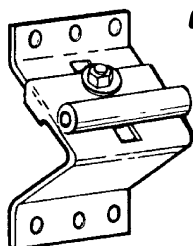

GD-52196 (2 pack)

Top Roller Fixtures

Contents: 2 fixtures without fasteners.

Description: Heavy duty **galvanized steel** fixture with adjustable roller plate; accepts a standard **7/16" diameter stem roller**; used on most wood doors.

Garage Door

GD-52220

Track Brackets

Contents: 1 #1 & 1 #3 track bracket; 2 ea. 1/4" -20 x 1/2" ribbed neck bolts with nuts.

Description: Steel brackets; used to fasten track to wall.

GD-52220

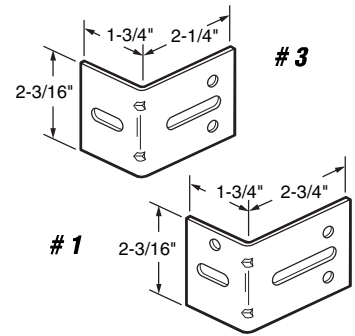

GD-52115 (Right Hand)

GD-52116 (Left Hand)

Bottom Lifting Brackets

Contents: 1 bracket; 3 ea. 1/4"-20 x 1-7/8" pancake head carriage bolts with nuts.

Description: Heavy duty 13 gauge galvanized steel construction steel cable pin used on most wood doors; accepts a standard 7/16" stem diameter roller. Handling viewed from inside garage.

You may wish to stock these related parts: GD-52100, GD-52101, GD-52115 and GD-52116.

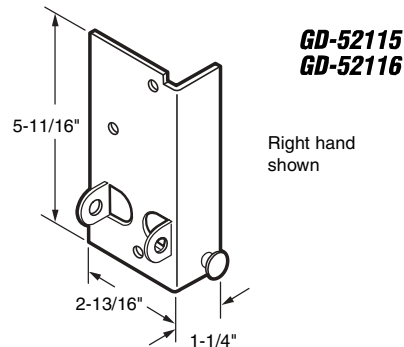

GD-52115
GD-52116

Right hand shown

GD-52197 (2 pack)

Bottom Lifting Brackets

Contents: 2 brackets (1 left hand and 1 right hand); without fasteners.

Description: Heavy duty 13 gauge galvanized steel construction steel cable pin; used on most wood doors; accepts a standard 7/16" diameter stem roller.

You may wish to stock these related parts: GD-52100, GD-52101, GD-52115 and GD-52116.

GD-52197

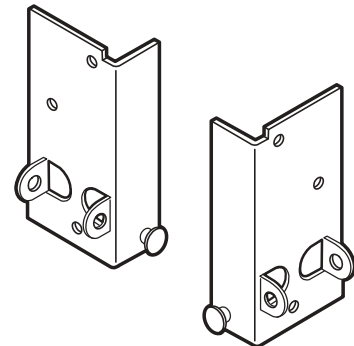

GD-52122 (Chrome - 1 pack)

GD-52200 (Chrome - keyed alike - 2 pack)

GD-52213 (Brass - 1 pack)

"T" Locking Handle

Contents: Locking handles with keys.

Description: Zinc diecast construction; keyed lock; 5/16" square shaft, 3" long; replaces most garage door, camper and R.V. locking handles.

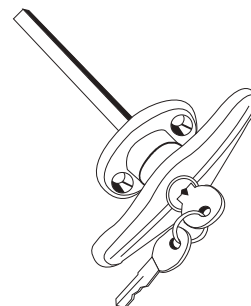

GD-52122
GD-52200
GD-52213

1-1/2" Hole Centers

GD-52144 (Chrome)

"T" Locking Handle

Contents: 1 locking handle; 2 keys.

Description: Zinc diecast construction; keyed lock; 5/16" square shaft, 2" long; replaces many garage door, camper and R.V. locking handles.

You may also wish to stock these related parts: GD-52121, GD-52123.

GD-52144

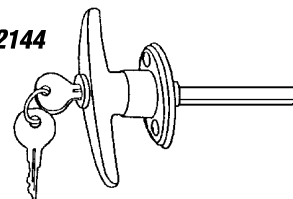

1-1/2" Hole Centers

GD-52169

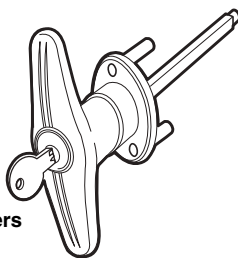

1-1/2" Hole Centers

GD-12121

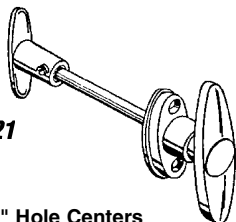

1-1/2" Hole Centers

4-1/4" Hole Centers

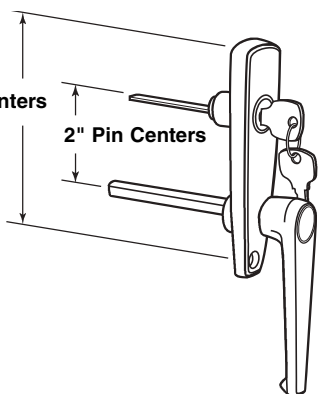

GD-52147

2" Pin Centers

GD-52123
GD-52201
GD-52214

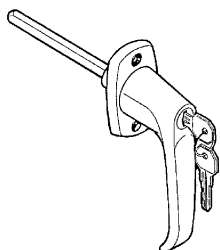

1-3/4" Hole Centers

GD-52148

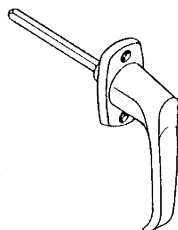

1-3/4" Hole Centers

GD-52169 (Chrome)

"T" Locking Handle

Contents: 1 locking handle; 2 keys.

Description: Zinc diecast construction; keyed lock; 5/16" square shaft, 3-5/8" long; replaces many garage door, camper and R.V. locking handles. Screws attach to lock from the inside of door.

GD-52121

"T" Handle

Contents: 1 outside handle; 1 inside handle with set screws.

Description: Diecast outside handle has 5/16" square, 3" long shaft; inside handle is diecast zinc with set screw; used when locking cylinder is mounted separately.

You may wish to stock this related part: **GD-52119**, **GD-152139**, **GD-52199**.

GD-52147 (Chrome)

"L" Handle and Locking Unit

Contents: 1 handle and housing; 1 cylinder lock with 2 keys; 1 set of installation fasteners.

Description: Plated diecast handle and housing with 5/16" square shaft, 3-1/8" long; keyed lock with break-off spindle; works with **GD-12138** slide lock.

You may wish to stock this related part: **GD-52138**.

GD-52123 (Chrome - 1 pack)

GD-52201 (Chrome - keyed alike - 2 pack)

GD-52214 (Brass - 1 pack)

"L" Locking Handle

Contents: Locking handles with keys.

Description: Zinc diecast construction; keyed lock; 5/16" square shaft, 2-7/8" long; replaces most garage door, camper and R.V. locking handles.

GD-52148 (Chrome)

"L" Handle

Contents: 1 handle.

Description: Diecast "L" handle with 5/16" square shaft, 3" long; non-keyed handle for use with various inside latching devices.

You may wish to stock these related parts: **GD-52119**, **GD-52199**.

*Call for
Availability*

Garage Door

GD-52138

Side Lock

Contents: 1 lock assembly.

Description: Heavy duty **galvanized steel, spring loaded, lock** with latch bolt release lever. Used with **GD-52147** outside lock and latch assembly.

You may wish to stock these related parts: **GD-52121, GD-52139, GD-52147.**

GD-52138

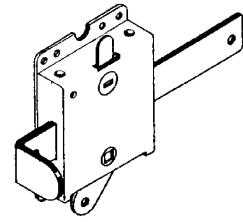

GD-52118

Inside Deadlock

Contents: 1 lock assembly; 4 ea. 1/4"-20 x 1-7/8" pancake head carriage bolts with nuts.

Description: 7/8" wide x 1/8" thick **steel slide bolt** with heavy duty **galvanized steel housing**; works only from the inside for extra protection as a **night or vacation security lock**; engages slot in vertical track; fits most garage doors.

GD-52118

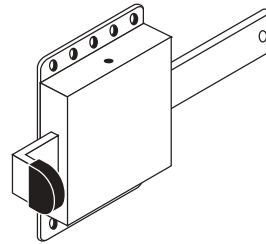

GD-52137

Slide Latch (Side Mount)

Contents: 1 latch.

Description: Heavy duty **galvanized steel** construction; spring loaded for positive latching; fits on **Frantz** and other manufacturers.

You may wish to stock these related parts: **GD-52162 thru GD-52165.**

Call for
Availability

GD-52137

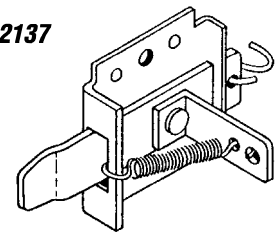

GD-52124

Snap Lock (Side Mount)

Contents: 1 latch; 1 latch strike; 3 ea. 1/4"-20 x 1-7/8" pancake head carriage bolts.

Description: Heavy duty **galvanized steel** construction; spring loaded for positive latching; will fit on most 2" track configurations; used by many manufacturers.

You may wish to stock these related parts: **GD-52120, GD-52122.**

GD-52124

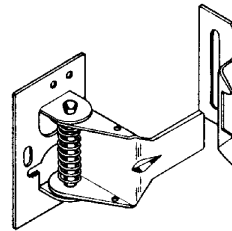

GD-52219

Strike Plate

Contents: 2 strikes; installation bolts.

Description: **Zinc plated steel** construction; used with many different style snap locks.

You may wish to stock these related parts: **GD-52120, GD-52122.**

GD-52219



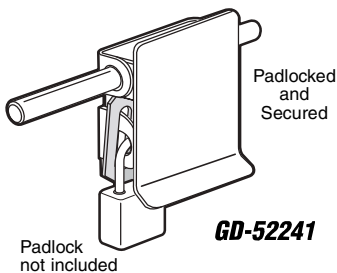
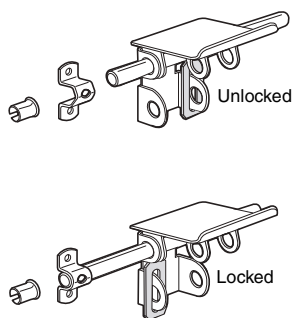

GD-52241

GD-52241

Garage & Shed Lock (Tamper-proof)

Contents: 1 latch; 2 bolt keepers; installation bolts.

Description: Heavy gauge zinc plated steel lock; has tamperproof cover plate; can be used with surface mount or mortise bolt keepers; use with a padlock.

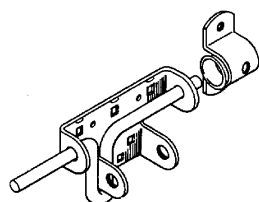

GD-52145

GD-52145

Slide Bolt Latch

Contents: 1 latch; 2 bolt keepers; 1 set of installation screws.

Description: Heavy gauge, zinc plated steel slide bolt latch with both surface mount or mortise bolt keepers. Use with a padlock.

GD-52166

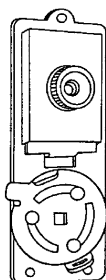

GD-52166

Night Latch

Contents: 1 lock assembly.

Description: Heavy duty galvanized steel; works with 5/16" square shaft exterior locking handle GD-52121 and GD-52139 rim cylinder; used on both *Frantz* fiberglass and wood doors.

You may also wish to stock these related parts: GD-52122, GD-52123, GD-52162, GD-52163, GD-52164, GD-52165.

Call for
Availability

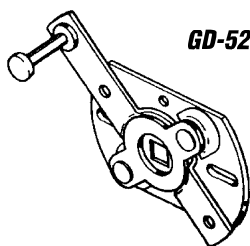

GD-52120

GD-52120

Swivel Latch (Center Mount)

Contents: 1 swivel latch; 4 ea. no. 8 x 1-1/4" Phillips pan head sheet metal screws.

Description: Heavy duty galvanized steel construction; accepts a 5/16" square shaft locking handle; fits on *Frantz* and others as a lever mechanism to disengage side latches.

You may wish to stock these related parts: GD-52122, GD-52123.

GD-52119

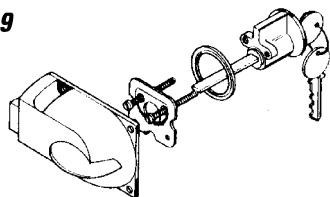

GD-52119 (Aluminum)

Center Mount Deadbolt Lock

Contents: 1 inside latch bolt assembly; 1 outside cylinder lock with 2 keys; 1 set of fasteners.

Description: Painted diecast inside lock with heavy duty steel spring bolt; key cylinder has aluminum face and 5 pin tumbler lock with cylinder ring, will replace most locking mechanisms of this type; used by many manufacturers.

You may wish to stock these related parts: GD-52139, GD-52199.

Garage Door

GD-52142

Electric Key Switch

Contents: 1 key cylinder with **plastic** housing and face plate assembly; 2 keys.

Description: Allows operation of garage door opener without a transmitter; mount to the exterior door jamb and hard wire to opener.

GD-52142

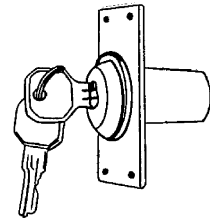

GD-52264 (Chrome)

Electric Key Switch (High Security)

Contents: 1 cylinder lock and housing assembly with 2 keys; 4 spiral nails.

Description: **Diecast** housing and waterproof cover; 7 pin cylinder lock has **chrome plated brass housing**; pick resistant, high security; momentary contact, uses 3 amp 250vac.

GD-52264

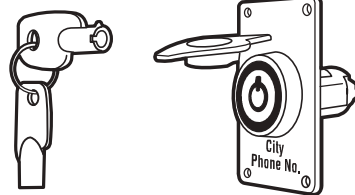

GD-52143 (Brushed chrome)

Emergency Release Kit

Contents: 1 key cylinder and housing assembly with 2 keys; 1 - 36" release cable; 1 set of fasteners.

Description: **Diecast** housing; designed to release automatic garage door opener in event of power failure; for garages without side access doors.

You may wish to stock this related part: **GD-52142**.

GD-52143

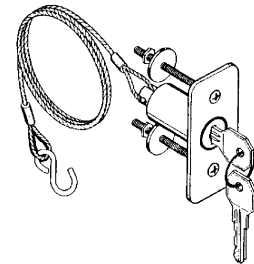

GD-52139

Rim Cylinder Lock

Contents: 1 cylinder lock with trim ring and 2 keys; 1 mounting plate and 2 screws.

Description: Heavy duty **zinc diecast housing** with **brass face** and **5 pin tumbler lock**. Used to key lock a variety of interior latching mechanisms.

You may wish to stock these related parts: **GD-52119**, **GD-52138**.

GD-52139

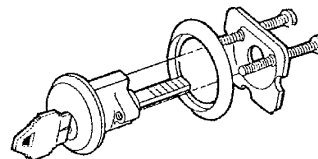

GD-52199

Lock Bar Disc

Contents: 1 disc.

Description: **Galvanized steel disc** is used to drive the door lock bars. Accepts a **5/16" square** shaft handle (**GD-52121**); acts as a keeper for **GD-52119** center mount deadbolt lock.

You may wish to stock these related parts: **GD-52119**, **GD-52121**, **GD-52139**.

GD-52199

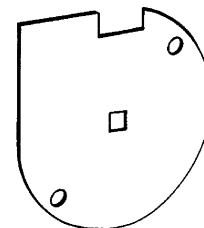

Extension Springs (with Safety Cable) for Sectional Overhead Type Doors

Contents: 1 spring per package; **minimum order quantity 6** springs each. **Rated at 10,000 cycles.**

Description: Heavy duty; extension springs. It is always advisable to replace all door springs, even though only one may have broken; safety cables protect against personal injury and property damage from broken springs.

Product Number	Spring Size	Color Code	Door Size	Number of Springs on Door	Springs on each Side
GD-12279	50 lbs.	Orange	• Use on Single car fiberglass doors	2	1
<i>(With Safety Cable)</i>					
(25" Long)					
GD-12202	70 lbs.	Yellow	• Use on single car fiberglass doors	2	1
<i>(With Safety Cable)</i>					
(25" Long)					
GD-12191	110 lbs.	Blue	• Wood Door, 8' Wide x up to 6'6" High; 2 Panels; 4 sections • Fiberglass Door, 16' Wide x up to 7' High; 4 Sections	2	1
<i>(With Safety Cable)</i>					
(25" Long)					
GD-12277	110 lbs.	Blue	• Use on Ta doors; for 2 car metal doors	2	1
<i>(With Safety Cable)</i>					
(29" Long)					
GD-12192	120 lbs.	Green	• Wood Door, 8' Wide x up to 7' High; 2 Panels; 4 Sections • Fiberglass Door, 16' Wide x 7' High; 4 Sections	2	1
<i>(With Safety Cable)</i>					
(25" Long)					
GD-12193	130 lbs.	Black	• Wood Door, 8' Wide x up to 7' High; 4 Panels; 4 Sections	2	1
<i>(With Safety Cable)</i>					
(25" Long)					
GD-12194	140 lbs.	Red	• Wood Door, 9' Wide x up to 7' High; 2 Panels; 4 Sections • Wood Door, 16' Wide x 7' High; 2 Panels; 4 Sections	2 4	1 2
<i>(With Safety Cable)</i>					
(25" Long)					
GD-12195	150 lbs.	Silver	• Wood Door, 9' Wide x 7' High; 4 Panels; 4 Sections • Wood Door, 16' Wide x 7' High; 4 Panels; 4 Sections	2 4	1 2
<i>(With Safety Cable)</i>					
(25" Long)					
GD-12207	150 lbs.	Silver	• 9' Wide x 7' High; 4 Panels; 4 Sections • 16' Wide x 7' High; 4 Panels; 4 Sections	2 4	1 2
<i>(With Safety Cable)</i>					
(22' Long - Special for Frantz doors)					
GD-12205	160 lbs.	Brown	• Wood Door, 9' Wide x 7' High; 4 Panels; 4 Sections • Wood Door, 16' Wide x 7' High; 4 Panels; 4 Sections	2 4	1 2
<i>(With Safety Cable)</i>					
(25" Long)					
GD-12267	170 lbs.	Yellow	• Wood Door, 10' Wide x 7' High; 4 Panels; 4 Sections • Wood Door, 16' Wide x 7' High; 8 Panel; 4 Sections	2 4	1 2
<i>(With Safety Cable)</i>					
(25" Long)					
GD-12278	285 lbs.	-	• Use on 2 car wood doors	2	1
<i>(With Safety Cable)</i>					
(28" Long)					

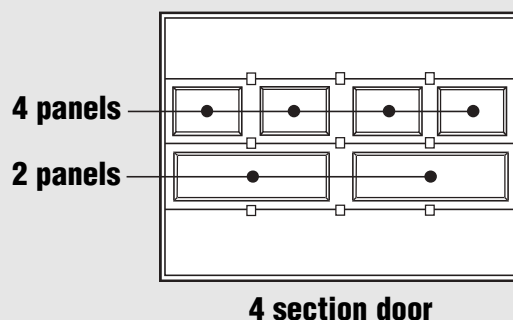
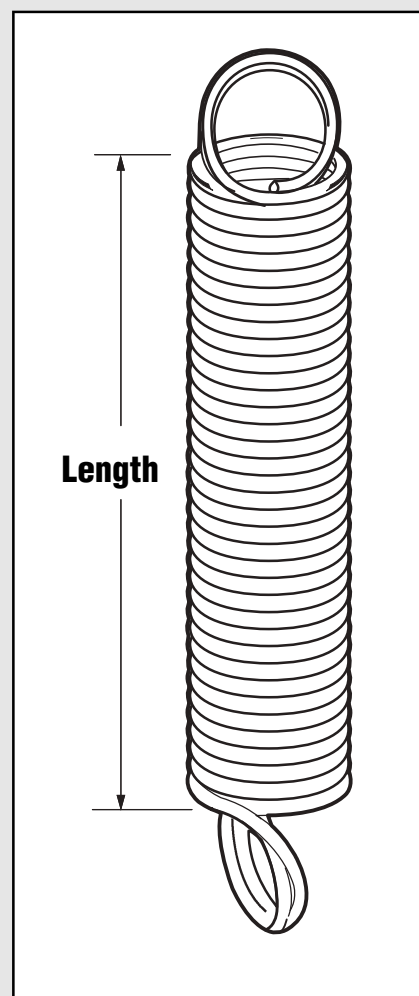

Garage Door

GD-52198 (2 plates for 3" pulley)
GD-52287 (2 pairs for 4" pulley)

Dual Spring Hook Plates

Contents: Hook plates.

Description: Galvanized steel plates used to attach 2 springs to the moving pulley strap. For heavy duty door applications.

You may wish to stock this related part: **GD-12108, GD-12109.**

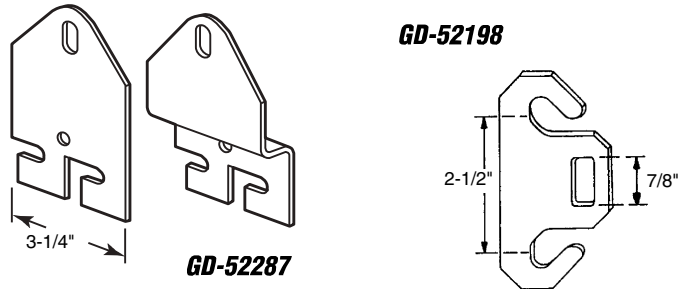

GD-12146 - 110/120 lbs. (#728)
GD-12255 - 135/145 lbs. (#528)

"One Piece" Door Spring

Contents: 1 spring.

Description: Very popular West Coast spring has stamped steel end plugs attached to safety containment rods; supplied with 2 "W" hook assemblies for either one or two spring replacement. These springs are approved and certified by the State of California Department of Housing and Community Development and comply with the California Building Standards Code (CBCS) Title 24, Part 2, Section 312.7.

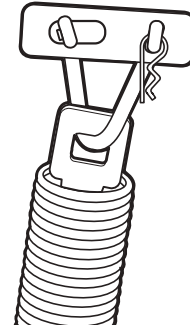

GD-12146
GD-12255

GD-12269 (16" long)
GD-12270 (16" long - includes safety cable)

"One Piece" Taylor Door Spring

Contents: 1 spring.

Description: Double loop spring; 1-1/4" I.D.; 10 coils = 1-7/8"; for single car garage doors. Uses a black color code.

GD-12269
GD-12270

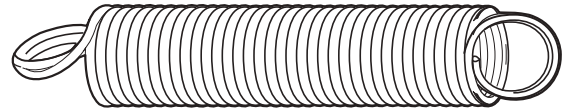

Torsion Springs

Contents: 1 spring with winding cone and anchor cone attached.

Part Number	Color Code	Wire Size	Inside Diameter	Overall Length	Wind
GD-12224	Silver	.207	1-3/4"	18"	Right
GD-12225	Silver	.207	1-3/4"	18"	Left
GD-12226	Blue	.218	1-3/4"	20"	Right
GD-12227	Blue	.218	1-3/4"	20"	Left
GD-12228	Red	.243	1-3/4"	32"	Right
GD-12229	Red	.243	1-3/4"	32"	Left
GD-12230	White	.250	1-3/4"	32"	Right
GD-12231	White	.250	1-3/4"	32"	Left
GD-12232	Yellow	.243	2"	32"	Right
GD-12233	Yellow	.243	2"	32"	Left
GD-12234	Green	.250	2"	32"	Right
GD-12235	Green	.250	2"	32"	Left

Description: Most doors, in recent years, have been supplied with torsion springs; located directly above the door and mounted to the header. Replacement will require the use of 2 - winding rods (**GD-12238**) and a clear understanding of wire size and handing. The chart at right will help to determine these two factors.

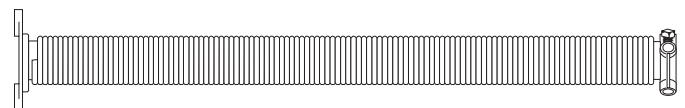

Measure 10 coils and refer to chart for wire size.

Wire Chart	Wire Size
	2-1/16" = .207
	2-3/16" = .218
	2-7/16" = .243
	2-1/2" = .250

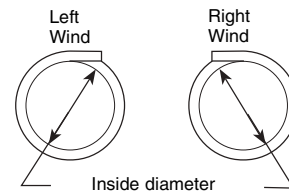
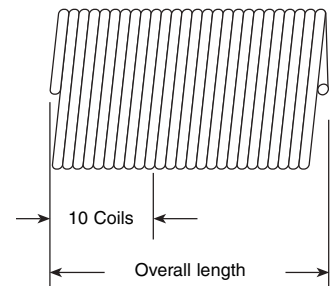

GD-12222
GD-12223

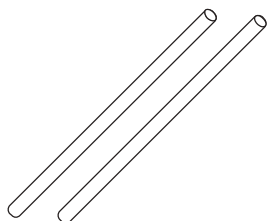
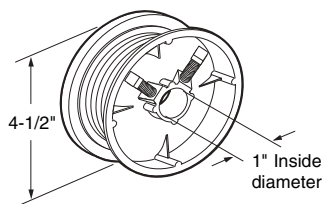

GD-52238

GD-52129
GD-52130

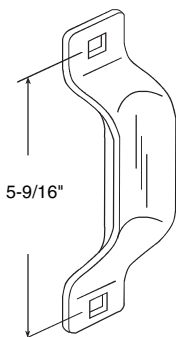
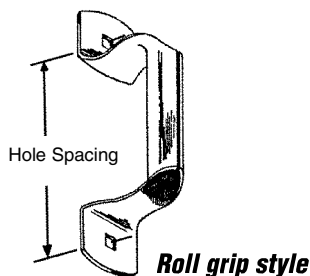

GD-52288
GD-52217

GD-52103

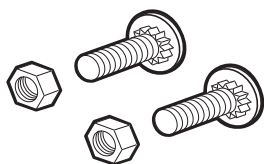
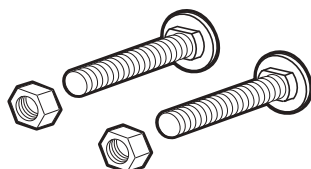

GD-52265

GD-12222 (Left hand)
GD-12223 (Right hand)

Torsion Spring Cable Drum

Contents: 1 cable drum, with set screws.

Description: Diecast cable drum used on torsion spring doors; spools lifting cable as door operates. Accepts cables up to 1/8" in diameter; maximum weight load, per drum, is 265 lbs. Color coded **Red** (right hand); **Black** (left hand).

GD-52238

Winding Rods

Contents: 2 winding rods.

Description: 1/2" diameter x 16" long, hard drawn wire rods; used to wind and unwind tension on torsion springs; **these are the only tools recommended for this purpose.**

GD-52129 (5" open grip)
GD-52130 (6" roll grip)

Bottom Lift Handle

Contents: 2 handles; 4 ea. 1/4" -20 x 1-7/8" pancake head carriage bolts with nuts.

Description: Galvanized steel construction; lift handle can be used in vertical or horizontal position; replaces most handles currently in use.

GD-52288 (Zinc plated)
GD-52217 (Brass plated)

Bottom Lift Handle

Contents: 1 handle; 2 ea. 1/4"-20 x 1-7/8" pancake head carriage bolts with nuts.

Description: Steel construction; handle can be used in vertical or horizontal position; replaces most handles currently in use.

You may wish to stock this related part: **GD-12129, GD-12130.**

GD-52103

Carriage Bolts With Nuts

Contents: 12 ea. 1/4"-20 x 1-7/8" pancake head carriage bolts; with nuts.

Description: Zinc plated bolts; used to attach most hardware to garage doors; flat head allows for smooth exterior finish.

GD-52265

Ribbed Neck Bolts With Nuts

Contents: 12 ea. 1/4" - 20 x 1/2" pancake head, ribbed neck bolts with nuts.

Description: Slotted, zinc plated bolts and hex nuts; used on fiberglass garage doors.

Garage Door

Call for
Availability

GD-12127 (9' long)
GD-12128 (16' long)

Weatherstrip (Fiberglass and Aluminum Door)

Contents: 1 vinyl strip.

Description: Gray vinyl material has excellent performance characteristics in all weather conditions. Fits on fiberglass and metal doors by *Frantz*, *Clopay* and many other manufacturers.

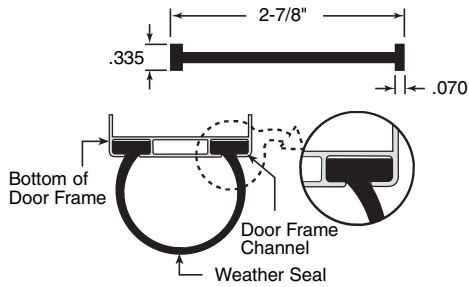

GD-12127
GD-12128

GD-12273 (10' long)
GD-12274 (16' long)

Weatherstrip (Metal Door)

Contents: 1 vinyl strip.

Description: Fits 1 piece & metal sectional doors, weatherstrip is constructed of a gray vinyl material. Will not freeze under sub-zero temperatures.

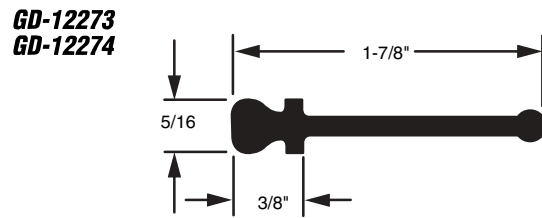

GD-12273
GD-12274

GD-12275 (10' long)
GD-12276 (16' long)

Weatherstrip (Metal Door)

Contents: 1 vinyl strip.

Description: Fits 1 piece & metal sectional doors, weatherstrip is constructed of a gray vinyl material. Will not freeze under sub-zero temperatures.

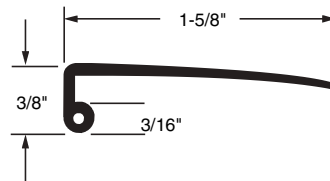

GD-12275
GD-12276

GD-12125 (9' long)
GD-12126 (16' long)

Weatherstrip (Wood Door)

Contents: 1 vinyl strip with nails.

Description: Black vinyl material has excellent consistency even in the coldest weather; will fit a standard 1-3/8" thick garage door; used by many wood door manufacturers.

GD-12125
GD-12126

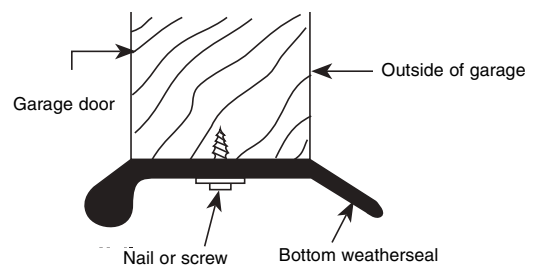

GD-12210

Key Blanks

Contents: 25 blanks per bag.

Description: Standard key blanks for re-keying "T" and "L" locking handles; for **GD-12122** and **GD-12123**.

GD-12210

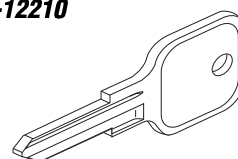

GD-12136

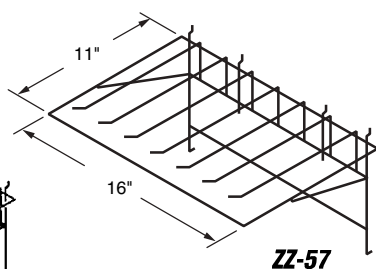
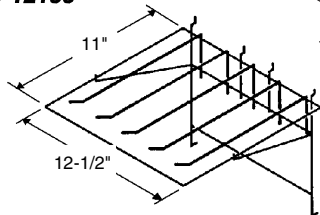

GD-12136 (5 prong)
ZZ-57 (7 prong)

Spring Rack

Contents: 1 wire rack.

Description: Plated steel wire rack holds up to 5 or 7 different sizes of springs; attaches to existing pegboard.

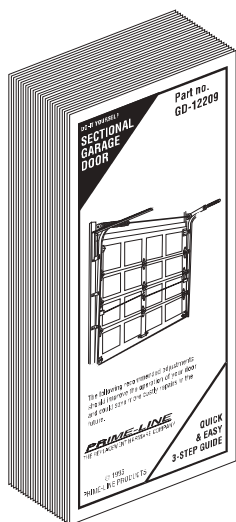

GD-12209

GD-12209
ZZ-34 (With wire rack)

Maintenance Brochures

Contents: 50 brochures.

Description: Complete how-to instructions on adjusting spring tension, leveling door, and general problem solving.

GD-12280

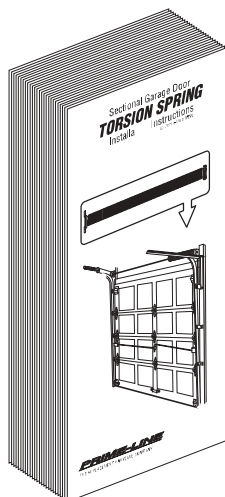

GD-12280
ZZ-58 (With wire rack)

Torsion Spring Brochures

Contents: 50 Brochures.

Description: Detailed instructions on how to remove and replace torsion springs. **NOTE:** It is advisable to use a professional installer for this project.

Can't find what your looking for ?

Call our customer service department at the number below. We may be able to source it for you!